

A - A 断面 S=1:2

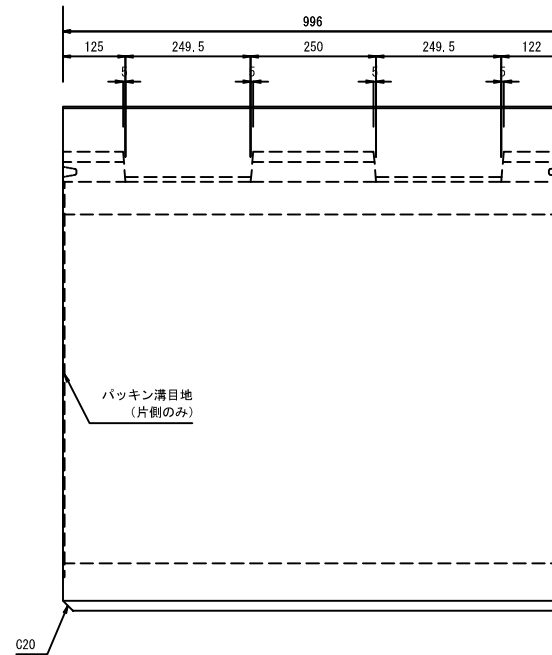
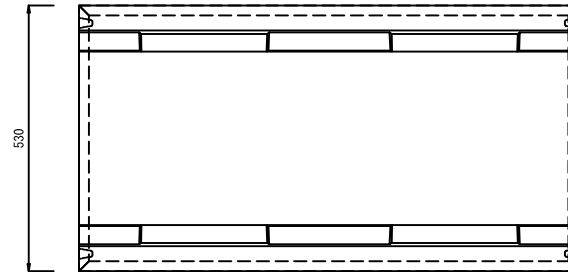
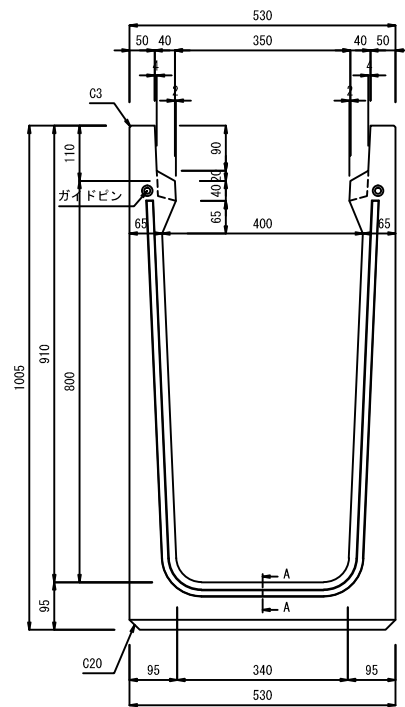
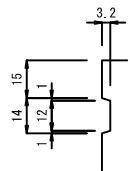

福岡県道路用コンクリート製品協同組合	S=1:10	E:2005.08.31	R:2006.07.05
FPU側溝 側溝規格図		参考重量	445 kg
T-25縦断 400×800			